



XALQARO YIRIK GABARITLI VA OG'IR YUKLARNI AVTOMOBIL TRANSPORTIDA TASHISH

Katta ko'lamdagi vazifalarni hal qilamiz!

ng-negabarit.com



01 YIRIK GABARITLI VA OG'IR YUKLARNI TASHISH

Har qanday yirik gabaritli va og'ir yuklarni xavfsiz va o'z vaqtida tashiymiz

02 MARSHRUTNI TEKSHIRISH VA ISHLAB CHIQISH

Marshrutlarni tahlil qilamiz va har bir yuk uchun optimal yo'lni tanlaymiz

03 BOJXONA RASMIYLASHTIRUVI

Chegara o'tishida kechikishlarsiz barcha zarur hujjatlarni rasmiylashtiramiz

YUK TASHISH PAYTIDA SUG'URTA

Yo'lning barcha bosqichlarida tinchlik uchun uchinchi shaxslar oldidagi javobgarlikni sug'urtalimiz

ОФОРМЛЕНИЕ СПЕЦИАЛЬНЫХ РАЗРЕШЕНИЙ

Yo'lning barcha bosqichlarida tinchlik uchun uchinchi shaxslar oldidagi javobgarlikni sug'urtalimiz

MULTIMODAL TASHISH

Optimal yetkazib berish uchun turli xil transport turlarini birlashtiramiz
ng-negabarit.kz | Katta ko'lamdagi vazifalarni hal qilamiz!

LOYIHA LOGISTIKASI

Har qanday murakkablik va konfigurasiyadagi loyiha yuklarini yetkazib berish bo'yicha kompleks yechimlarni tashkil qilamiz

QIMMATBAHO YUKLARNI TASHISH

Qimmatbaho yuklarni kuchaytirilgan xavfsizlik va nazorat ostida tashiymiz

YUKLARNI HAMROHLIK AVTOMOBILLARI BILAN KUZATIB BORISH

Yo'lning har bir bo'limida harakat va xavfsizlikni nazorat qilamiz

SIZNING VAZIFALARINGIZ UCHUN BIZNING QUVVATLARIMIZ

- 1 OCHIQ PLATFORMALAR**
Ko'tarish qobiliyati 22 tonnagacha, 3 o'q
- 2 PAST RAMALI TRALLAR**
Ko'tarish qobiliyati 45 dan 100 tonnagacha, 4-8 o'q
- 3 MODULLI TRALLAR**

YARIM TIRKAMALAR:

FAYMONVILLE, KASSBOHRER, GOLDHOFER,
ТВЕРЬСТРОЙМАШ, NOOTEBOOM, BROSHUIS,
MAXTRAILER, TSR, GUOSHI HUABANG, HYST

YUK TORTUVCHILAR

VOLVO, MAN, SCANIA, DAF, RENAULT, SHACMAN



MUHANDISLIK TRANSPORT YECHIMLARI

Og'irlik, o'lchamlar va marshrutga qarab texnika va konfiguratsiyalarni tanlaymiz

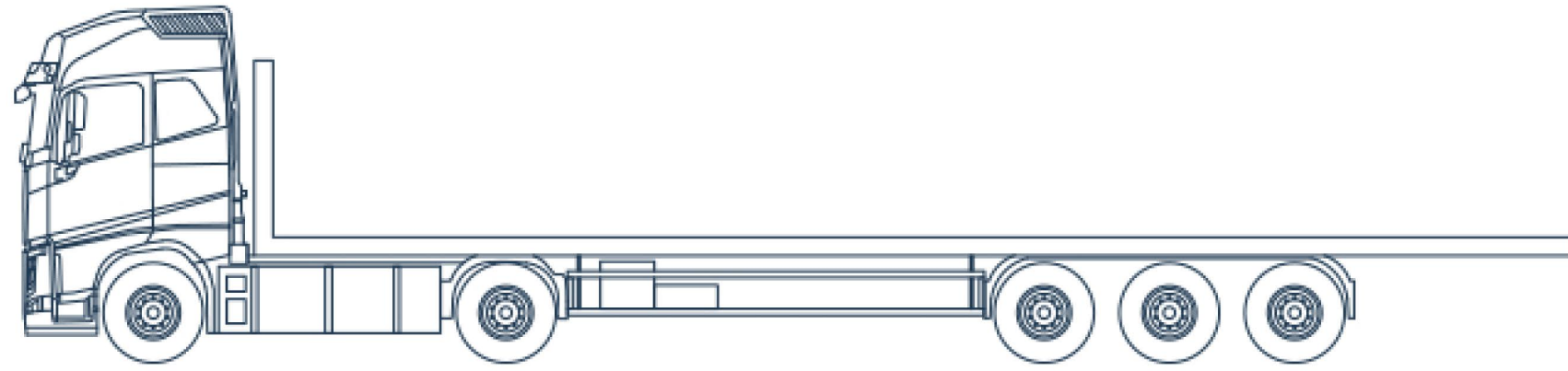

3 o'qli ochiq platforma

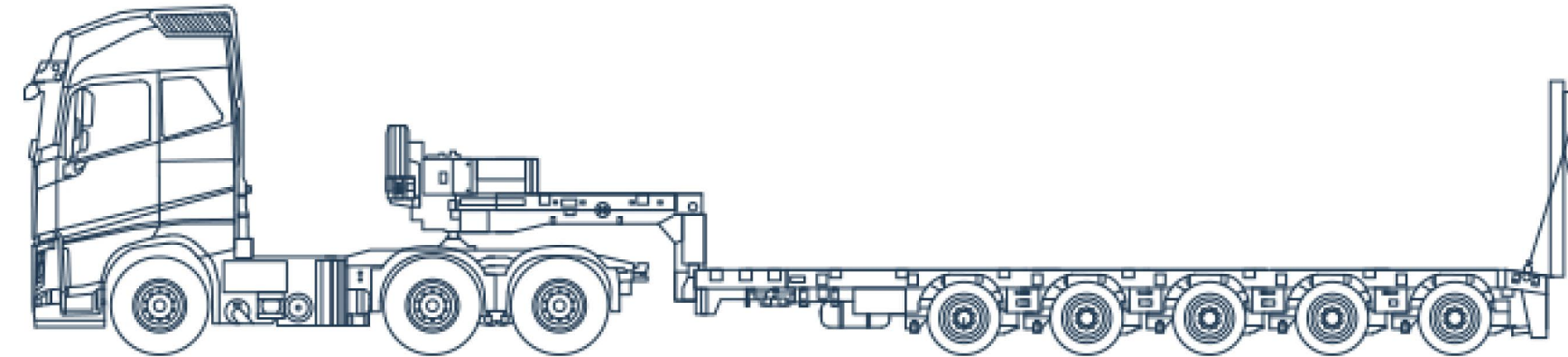

5 o'qli og'ir yuk tirkamasi

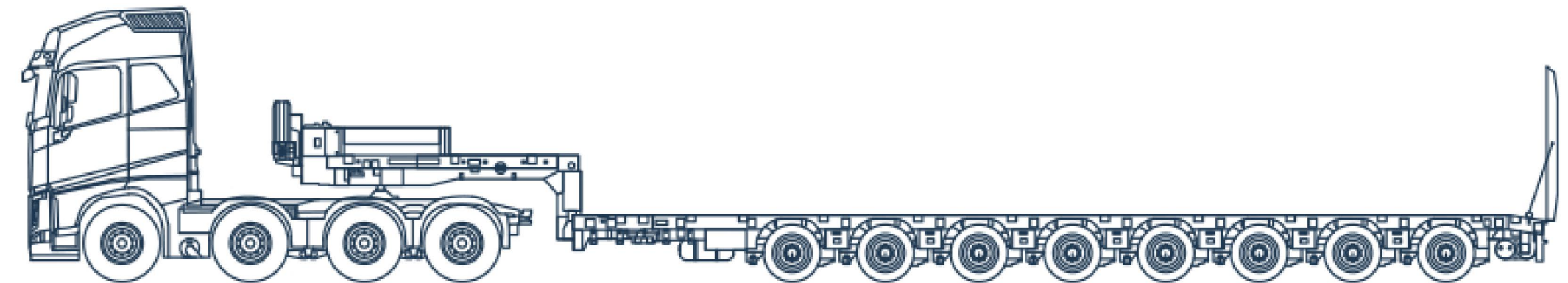

8 o'qli og'ir yuk tirkamasi

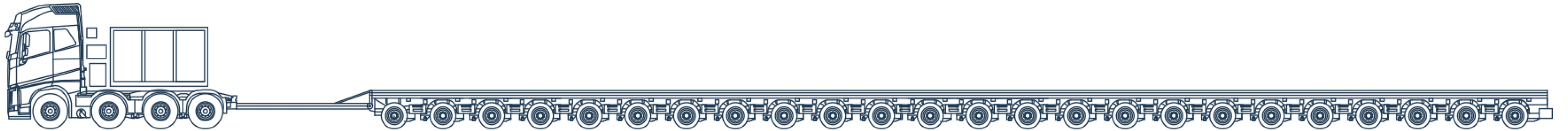

Egarli-ballastli yuk tortuvchi va 24 o'qli modulli yarim tirkama

Konstruktiv jihatdan majmua 24 ta o'zaro almashtiriladigan modulli liniyalardan iborat. Adaptiv arxitektura yuk poyezdi (avtopoyezd) konfiguratsiyasini yukning aniq vazni va o'lchamlariga qarab tezda o'zgartirish imkonini beradi:

Har biri 6 liniyadan iborat 2 ta tarkib — og'irligi taqsimlangan og'ir yuklar uchun.

Har biri 4 liniyadan iborat 3 ta tarkib — bir vaqtning o'zida bir nechta obektlarni tashish uchun.

Yagona platforma (24 liniyagacha) — o'ta og'ir va bo'linmas (yaxlit) konstruksiyalar uchun.

GEOGRAFIYA VA MURAKKABLIK: KEYSLARIDAGI TAJRIBAMIZ



«TALIMARJON IES» LOYIHASI

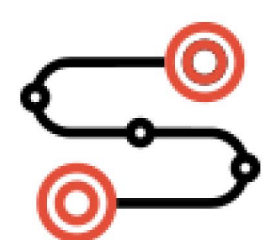

XORGOS (XXR)

⊙ --- 1670 km --->

TALIMARJON (O'ZR)

106 t – 6 dona – 29300×3900×4100 mm

180 t – 3 dona – 29300×3900×4100 mm

240 t – 3 dona – 29300×3900×4100 mm

258 t – 6 dona – 29300×3900×4100 mm

Loyiha videosini ko'rish



XORGOS (XXR) - TALIMARJON (O'ZR)

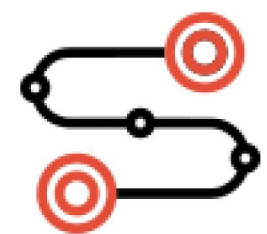

XORGOS (XXR)
 Ⓞ --- 1670 km -->
 TALIMARJON (O'ZR)

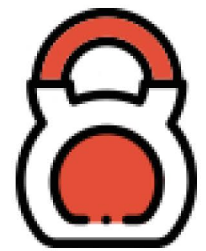

37 135 kg

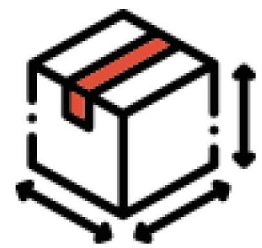

10830×7800×3400 mm

Loyiha videosini ko'rish

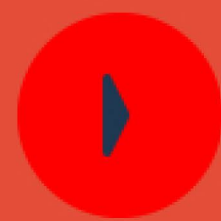



2026

«ZOOMLION» LOYIHASI



XORGOS (XXR)

○ --- 5300 km --->

RF, BELARUS

JAMI 173 DONA AVTOTRANSPORT VOSITASI
JALB QILINDI: PAST RAMALI TRALLAR
VA OCHIQ PLATFORMALAR

Loyiha videosini ko'rish

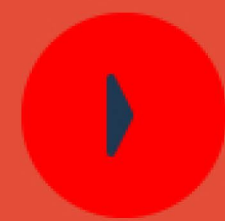

ng-negabarit.com



Katta ko'lamdagi vazifalarni hal qilamiz!



2026

«ZOOMLION» LOYIHASI



XORGOS (XXR)

⊙ --- 5300 km --->

RF, BELARUS

JAMI 173 DONA AVTOTRANSPORT VOSITASI
JALB QILINDI: PAST RAMALI TRALLAR
VA OCHIQ PLATFORMALAR

Loyiha videosini ko'rish



NOMI	OG'IRLIGI (t)	O'LCHAMLARI (UEB, MM)	SONI
ZOOMLION ZE 215 E	21,5	9600 × 2800 × 3100	113
ZOOMLION ZE 245 E	24	9775 × 3190 × 3285	5
ZOOMLION ZE 155 E	14,5	8000 × 2700 × 3100	4
ZOOMLION ZE 330 E-10	32	11 000 × 2800 × 3000	1
ZOOMLION ZE 370 E	34,6	11 268 × 3190 × 3500	14
ZOOMLION ZE 335 E	31,5	11 200 × 3200 × 3400	5
ZOOMLION ZE 370 EPRO	34,6	11 268 × 3190 × 3500	4
ZOOMLION ZE 245 EPRO	24	9 775 × 3190 × 3285	15
ZOOMLION ZE 135 E -10	14	8 100 × 2500 × 2900	11
ZOOMLION OFF-HIGHWAY DUMP TRUCK ZT188	35	16 400 × 4200 × 3900	1

«RNK» LOYIHASI

XORGOS (XXR)
 ⊙ --- 3700 km --->
VOLJSKIY (RF)

Zamonaviy ishlab chiqarish majmuasi — «Russkaya nerjaveyushchaya kompaniya» qurilishi uchun jihoz va materiallarning muntazam yetkazib berilishini tashkil etish.





XORGOS (XXR) SUXOY LOG (RF)



65 360 kg

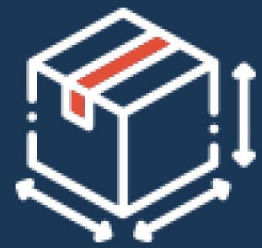

Ø 6800 mm, H-1000 mm



4 800 km

Loyiha videosini ko'rish

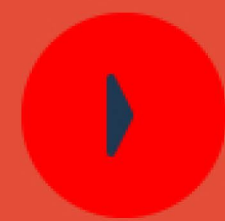

XORGOS (XXR) – BOKU (OZARBAYJON)

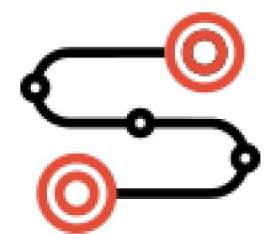

XORGOS (XXR)
 Ⓞ --- 4 400 km --->
 BOKU (OZARBAYJON)



63 550 kg

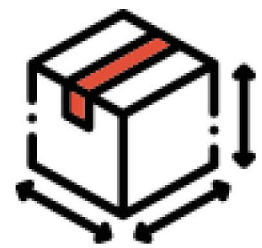

18800×3500×3850 mm



XORGOS – NIJNEKAMSK

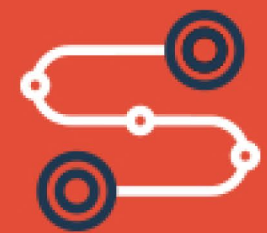

XORGOS (XXR)
 ○ --- 3420 km --->
 NIJNEKAMSK (RF)



Yuklar og'irligi:
 75,5 t gacha | bitta dona

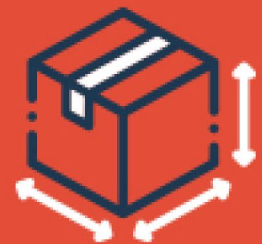

uzunligi: 11 m dan 27 m gacha
 kengligi: 3,2 m dan 5,4 m gacha
 balandligi: 2,9 m dan 4,6 m gacha

Loyiha yuklarining kompleks logistikasi (chillerlar, resiverlar, sig'imlar). Biz to'liq muhandislik tayyorgarligini ta'minladik: yuklash sxemalarini ishlab chiqishdan va tirkamalarni mustahkamlashdan tortib, butun yo'l davomida hamrohligigacha. Barcha jihozlar Nijnekamskdagi maydonchaga belgilangan jadval bo'yicha (2025-yil dekabr – 2026-yil yanvar) o'z vaqtida yetkazildi.



Loyiha videosini ko'rish

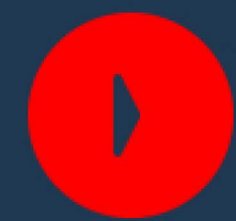

VOLGOGRAD (RF) –FARG‘ONA (O‘ZR)

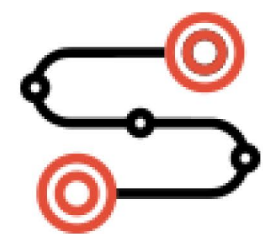

VOLGOGRAD (RF)
⊙ ---3150 km---→
FARG‘ONA (O‘ZR)

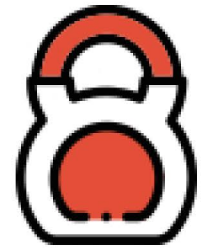

61 000 kg

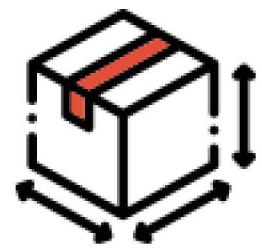

12310×3100×3000 mm



VEYXAY (XXR) – VELIKIY NOVGOROD (RF)



156 000 kg



12762×5250×4800 mm



9 800 km

Kimyo sanoati uchun o'ta og'ir va yirik gabaritli uskunalarni xalqaro miqyosda quruqlik orqali tashish bo'yicha murakkab operatsiya tashkil etildi va muvaffaqiyatli bajarildi. Veyxaydan (XXR) Velikiy Novgorodga (RF) bir vaqtning o'zida amalga oshirilgan ikkita quruqlik reysi orqali o'rtacha haroratli uglerod oksidi konverterlari yetkazib berildi. Yakuniy manzil — kimyo tarmog'ining yirik ishlab chiqarish majmuasidir.



Loyiha videosini ko'rish

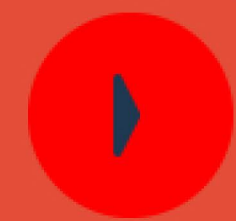

NUR JO'LI (QR)– KOVALYOVKA QISHLOG'I (RF)

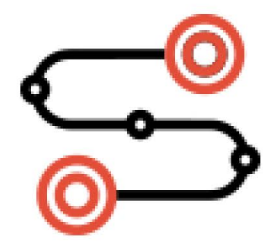

NUR JO'LI (QR)
⊙---4260 kg---→
KOVALYOVKA QISHLOG'I (RF)

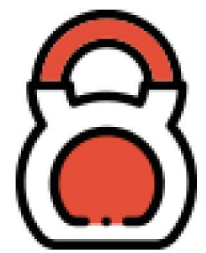

37 700 kg

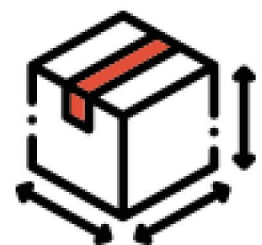

6000×3100×3600 mm





2026

ANSHAN- SANKT-PETERBURG

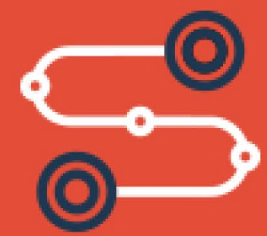

ANSHAN (XXR)
⊙---8700 km---→
SANKT-PETERBURG (RF)



44 500 kg

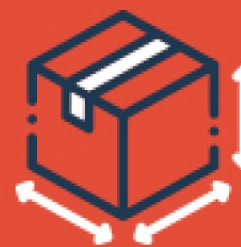

14000×6000×2000 mm

Loyiha videosini ko'rish

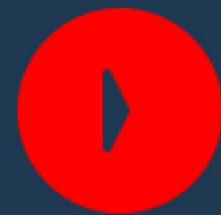

ng-negabarit.com



Katta ko'lamdagi vazifalarni hal qilamiz!

BIZNING TAJRIBAMIZ AMALDA



NG-NEGABARIT sanoat rivojlanishini faol kuzatib boradi va ilg'or amaliyotlarni joriy etadi. Innovatsiyalarga sodiqligimiz va bozor yetakchisi maqomimizning tasdig'i sifatida biz Almatidagi «TransLogistica 2025» xalqaro ko'rgazmasida ishtirok etdik.

Biz nafaqat trendlarga ergashamiz – balki ularning shakllanishida ishtirok etamiz, negabarit yuk tashish sohasidagi tajribamiz va eng zamonaviy yechimlarimizni taqdim etamiz.

Biz bilan ishlaganda, siz har doim bir qadam oldinda bo'lgan hamkorni tanlaysiz.

NG-NEGABARIT: «TRANSLOGISTICA 2025» ALMATI KO'RGAZMASI ISHTIROKCHISI

Sizning loyihalaringiz eng yaxshisiga loyiq. Konsultatsiya uchun biz bilan bog'laning



Bizning manzilimiz:

QR, Almati sh., Jandosov ko'chasi 98, «Navoi» BM, 306-xona

Bizning aloqa ma'lumotlarimiz:



+7 (776) 620 0013



info@ng-negabarit.kz



ng-negabarit.com

Hisob-kitob uchun ariza qoldirish



Kompaniya kartochkasini ochish uchun
telefon kamerasini yo'naltiring